

OUTDOOR LIVING

BRUSTOR[®]
OUTDOOR SUN SYSTEMS







Scan the QR code for the brochure
with our awnings, screens and
conservatory awnings

CONTENTS

Why choose Brustor?	4
Three types of patio covers	6
Your patio cover in three steps	8
Louverd roofs	10
Glass and/ or louverd patio roof	30
Fabric roof	44
Configurations	64
Options	66
Technological benefits	70
Quality & warranty	72
Hospitality industry solutions	74

BRUSTOR, QUALITY THAT MATCH YOUR STYLE.

Sun Protection expert Brustor crafts **timeless and innovative** designs tailored to every style, from rustic country living to cutting-edge contemporary.

Premium quality materials guarantee long-lasting Outdoor Living solutions for maximum satisfaction. And naturally, every outdoor living patio cover boasts a perfect, meticulous finish.

Our extensive range of layouts and add-on features allows you to personalise your Outdoor Living space **to your heart's content.**

Browse our brochure and get inspired by our latest solutions.





————— CREATE THE ULTIMATE RELAXATION SPACE



Bask in the outdoors from spring's first blossoms through late autumn under the eaves of an **innovative Brustor pergola** – all hours of the day.

Expand your living space into your garden or terrace to infuse time spent outdoors with the luxury of indoor living. Cherish those everyday special moments that give you that holiday feel.



LOUVERD ROOFS

Louverd roof pergolas allow you to customise your terrace and home's natural light and temperature. You decide how much shade or fresh air by adjusting the louver settings.

Discover all the styles and options available for **rotating and/or retractable louverd roofs**. Choose from a wide range of add-on features, designs, and colours.



GLASS AND/OR LOUVERD ROOF

Do you dream of enjoying the best light, shade, and ventilation – indoors and outdoors? Does that include a dry, safe space to house your furniture or an outdoor kitchen? The benefits and options are endless, with an innovative add-on patio cover featuring a fixed roof section with glass or sandwich panels and a roof section with rotating louvers. Always in a streamlined, contemporary design.



FABRIC ROOF

Brustor pergolas with a fabric roof are always immaculately elegant in every configuration. The design is carefully considered, with built-in screens, concealed screws, hidden drains, and high-grade fabric. Go with a standard shade or choose your favourite RAL colour. Brustor's outstanding patio covers are fully customisable.



THREE TYPES OF PATIO COVERS

FOUR SEASONS OF ENJOYMENT

A wonderfully warm spring, a phenomenal summer or a mild autumn... Enjoy your garden, terrace, and the perfect amount of natural light all year round with a Brustor pergola.

Whether you opt for a louverd roof with a glass roof section to maximise your home's natural light, a full louverd roof that you can control and customise, or a retractable pergola: Brustor creates the perfect home and garden experience for every season.

YOUR PERFECT PATIO COVER

IN 3 STEPS



1/ STAND-ALONE, WALL-ATTACHED OR BUILT-IN

Where would you like your patio cover? Over the terrace, to provide the perfect shade and keep temperatures inside comfortable? By the pool? Or would you prefer to add a roof to an existing structure? Choose from stand-alone, lean-to, or built-in.



2/ LOUVERD ROOF, GLASS & LOUVERS OR FABRIC ROOF

Do you want a flexible louverd roof that allows you to decide the amount of light, sun, and ventilation by retracting or rotating louvers? Or would you prefer a fixed glass roof and louver combination? How about a pergola with a retractable cover (folding or roll-up) that you can open or close at will? You decide!



3/ OPTIONS

Personalise your pergola effortlessly with add-on features. Set the mood with LED lighting, add heating for those chilly nights, customise your screen from a wide range of sun protection fabrics, or add built-in electrical sockets and speakers. You can also choose the colour of the frame and louvers.





LOUVERED ROOFS

CUSTOMISED SUN PROTECTION

B160 XL Page 12

B200 (XL) Page 16

B250 XL Page 22

B600 S Page 26





STREAMLINED ELEGANCE.

Looking for the perfect source of year-round outdoor recreation? Get that and more with the B160 XL. This patio cover has a compact, elegant design due to the concealed screws and/or patio mounts. You choose the colour and size to perfectly tailor the B160 XL to your home and garden.



B160 XL

BENEFITS & SPECIFICATIONS

SPECIFICATIONS

Stylish entry-level model

Concealed mounting materials

Hidden drainage inside poles

Stand-alone or wall-attached

Extendable in length

Comes standard with RTS or IO operation, remote control included

Available in any colour

BENEFITS

Multiple configuration options

Optional frame-mounted screens seamlessly integrated with the posts

Limitless selection of options

Made-to-measure, down to the last cm



B160 XL



OPTIONS

- Optional frame-mounted zip-screens
- Dimmable LED strips in structure
- Dimmable LED strips in louvers (white)
- Dimmable direct LED lighting on gutters (DOWN)
- Patio heating
- Electrical socket in pole
- Optional woodlook louver



OPERATION

- Somfy IO or RTS remote control



MAX. DIMENSIONS

6 m x 4,5 m



Extendable in length



STANDARD COLOURS

RAL
7016 ST

RAL
9016 ST

B200 XL

THE CROWD PLEASER.

The B200 (XL) is Brustor's most comprehensively developed, versatile pergola, with endless personalisation options. Its automated louverd roof allows you to adjust the louvers and set the perfect amount of light or shade at any time of the day. Available in large sizes and various configurations, you design the patio cover that's right for your terrace.

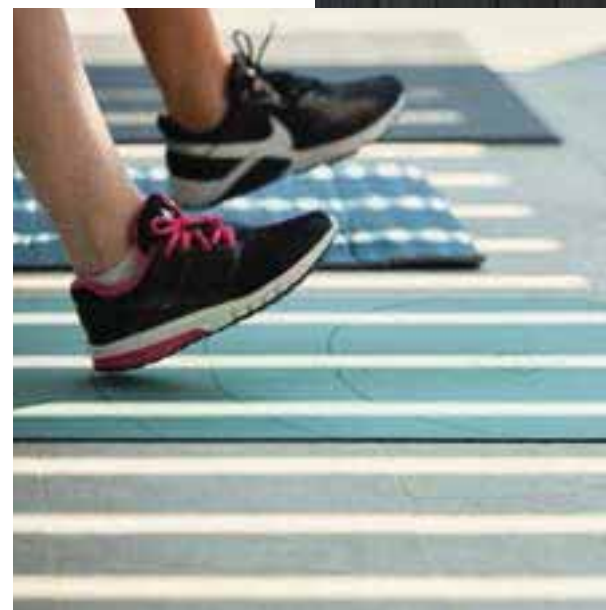
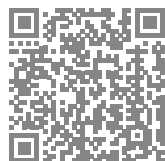



BENEFITS & SPECIFICATIONS

SPECIFICATIONS

Streamlined, minimalist design

Integrated screens for full privacy

Concealed mounting materials

Hidden drainage inside poles

Stand-alone, wall-attached, L- or star configuration

Can be coupled along the length or width

Comes standard with IO operation, remote control included

Available in any colour

BENEFITS

Multiple configuration options

Most versatile patio cover on the market

Limitless selection of options



B2000 XL



OPTIONS

- Integrated customisable ZIP screens
- Dimmable LED spots in frame
- Dimmable LED strips in louvers (B200: white – B200 XL: RGB or white)
- LED lighting on gutters (UP/DOWN)
- Patio heating
- Electrical socket in pole
- Bluetooth speakers
- Door profile
- Overhang
- Optional woodlook louver



OPERATION

- Somfy IO remote control



MAX. DIMENSIONS

- 7 m x 3,5 m (B200 single roof)
- 7 m x 4 m of 6 m x 4,5 m (B200 XL single roof)
- 6 m x 6 m (double roof)
- 7 m x 7 m (double roof with two additional support poles)
- Extendable in length and width



STANDARD COLOURS

RAL
7016 ST

RAL
9016 ST

RAL
7039 ST

RAL
9005 ST

enkel B200 XL

B2000



MULTIPLE CONFIGURATION OPTIONS

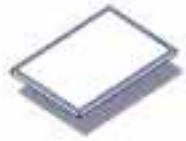

Frame only



Stand-alone



Stand-alone with
overhang



Coupled roof



Coupled roof with
door profile



Coupled in length
or width



L-configuration



Star configuration



Wall-attached



Wall-attached with
door profile



Wall-attached with
overhang





SUPERIOR PROTECTION.

B250 XL's sleek patio cover has wide louvers that seamlessly integrate with the drainage system for a dry and drip-free experience. Add integrated screens and patio heating to windproof your pergola and conserve radiant heat. Your remote control, smartphone, or tablet make patio cover operation carefree.



B250 XL

BENEFITS & SPECIFICATIONS

SPECIFICATIONS

Louvers seamlessly close onto the gutters

Integrated screens for full privacy

Fully concealed mounting materials

Hidden drainage in poles

Stand-alone or wall-attached

Extendable along length or width

Comes standard with RTS operation, remote control included

Available in any colour

BENEFITS

Splash and drip-proof thanks to the seamless integration of the louvers and the gutters

Better conservation of patio heating

Exceptionally sleek design thanks to perfectly flat louvers



B250 XL



OPTIONS

- Integrated customisable ZIP screens
- Dimmable LED spots in frame
- Dimmable LED strips in louvers (white)
- Patio heating
- Electrical socket in pole
- Bluetooth speakers
- Door profile



OPERATION

- Somfy RTS remote control



MAX. DIMENSIONS

- 6,06 m x 4 m (single roof)
- 6,06 x 6 m (double roof with two additional support poles)



- Extendable in length
- Extendable in width



STANDARD COLOURS



All RAL colours included

S
O
O
S
B

A SENSE OF OPENNESS.

The elegant B600 S patio cover provides the perfect sun protection. With louvers that retract to almost the full length, you get the best natural light across all seasons, even indoors. A gorgeous sunny autumn day, or one that's overcast, or even a day with light rain showers? The B600 S adapts to your needs all year round. Even better, B600 S's integrated screens provide you with the best protection.





BENEFITS & SPECIFICATIONS

SPECIFICATIONS

Compact retractable S-shaped louvers

Integrated screens for full privacy

Fully concealed mounting materials

Sophisticated drainage system

Stand-alone or wall-attached

Easy operation with your smartphone's Brustor Connect App

Available in any colour

BENEFITS

Roof opens up to 87%

More light indoors thanks to the sliding roof

Limitless selection of options



B600 S



OPTIONS

- Integrated customisable ZIP screens
- Dimmable LED spots in frame (all around)
- Dimmable LED strips in louvers (white)
- Indirect LED lighting on gutters (UP/DOWN)
- Patio heating
- Electrical socket in pole
- Bluetooth speakers
- Door profile



OPERATION

Brustor Connect operation by remote or smartphone (Brustor Connect A)



MAX. DIMENSIONS

6,09 x 4 m



STANDARD COLOURS

RAL
7016 ST

RAL
9016 ST



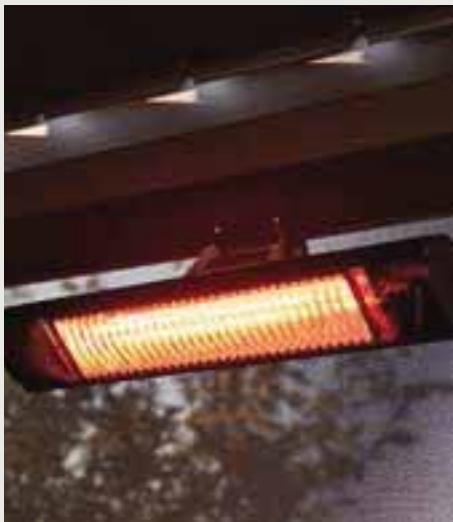

GLASS AND/OR LOUVERED ROOFS

SUN PROTECTION AND NATURAL LIGHT IN ONE

B700 Page 32

B720 Page 36

B800 Page 40





SLEEK DESIGN.

This innovative, closed-roof patio cover is compatible with sandwich or glass panels, with maximum natural light in your home when you choose glass. The B700 is also a natural choice for a stylish carport, or jacuzzi or outdoor pool enclosure. The B700 can be coupled. Extendable in length or width, which opens up a world of possibilities.



B700

BENEFITS & SPECIFICATIONS

SPECIFICATIONS

Available with glass or sandwich panels

Integrated screens for full privacy

Sleek design

Fully concealed mounting materials

Comes standard with IO operation, remote control included

Hidden drainage inside poles

BENEFITS

Additional permanent outdoor space under the patio roof

Fantastic natural light in your home with a fixed glass roof

Numerous possible applications



B700



OPTIONS

- Integrated ZIP screens
- Dimmable LED spots in frame
- Dimmable LED spots in intermediate beam
- Patio heating
- Electrical socket in pole
- Bluetooth speakers
- Door profile



OPERATION

- Somfy IO remote control



MAX. DIMENSIONS

- 6 x 2,50 m (single roof)
- 6 x 4 m (single roof)
- 5 x 5 m (double roof)



- Extendable in length
- Extendable in width



STANDARD COLOURS

RAL
7016 ST

RAL
9016 ST

B720

ULTIMATE FLEXIBILITY.

B720 is the ultimate flexible patio cover. Combining an area with a fixed glass or sandwich panel roof and a section with rotating louvers opens up a world of possibilities. Imagine a dry space with an outdoor lounge or dining furniture and an outdoor kitchen, a stylish sheltered bar, or garden storage paired with an inviting outdoor terrace.





BENEFITS & SPECIFICATIONS

SPECIFICATIONS

Available with glass or sandwich panels

Width of fixed roof section (glass or sandwich panel) is maximum 2.50 m

Integrated screens for full privacy

Sleek design

Fully concealed mounting materials

Comes standard with IO operation, remote control included

Hidden drainage inside poles

BENEFITS

Additional permanent outdoor space under the patio roof

Fantastic natural light in your home with a fixed glass roof

Numerous possible applications



B720



OPTIONS

- Integrated ZIP screens
- Dimmable LED spots in frame
- Dimmable LED spots in intermediate beam
- Dimmable LED strips in louvers (RGB or white)
- Indirect LED lighting on gutters (UP/DOWN)
- Patio heating
- Electrical socket in pole
- Bluetooth speakers
- Door profile
- Optional woodlook louver



OPERATION

- Somfy IO remote control



MAX. DIMENSIONS

- 6 x 7 m (double roof) - fixed roof part max 2,50 m



STANDARD COLOURS

RAL
7016 ST

RAL
9016 ST





ROBUST ELEGANCE.

The B800 is an aluminum pergola with a fixed glass roof, offering the best of both worlds: an attached outdoor pod while preserving natural light in the house.

The combination of a cubist look and robust structure creates a sleek appearance and the glass panels are discreetly sloped to shed rainwater.



BENEFITS & SPECIFICATIONS

SPECIFICATIONS

Attached via wall connection profile, or stand-alone on 4 posts

Available with glass or sandwich panels

Integrated screens for full privacy

Sleek design

Fully concealed mounting materials

Comes standard with IO operation, remote control included

Hidden drainage inside poles

BENEFITS

Additional permanent outdoor space under the patio roof

Fantastic natural light in your home with a fixed glass roof

Design is more modern than ever



BD 3800



OPTIONS

Integrated ZIP screens

Dimmable LED spots in frame

Dimmable LED spots in intermediate beam

Patio heating

Door profile



OPERATION

Somfy IO remote control



MAX. DIMENSIONS

7 x 4 m



STANDARD COLOURS

RAL
7016 ST

RAL
9016 ST





FABRIC ROOFS

STYLISHLY FLEXIBLE SUN PROTECTION

B128 Page 46

B128 P HORIZONTAL Page 50

B128 XL Page 54

B300 Page 60

B128

CLEAN & CUSTOMISED.

The Brustor B128 pergola is an incredibly versatile sun protection solution distinguished by its minimalist design and endless customisability. Expertly designed, this cover offers a panoramic view of the garden and plenty of natural light in your home. The B128 is always wall-mounted and combines the assets of an awning with those of a patio roof.





BENEFITS & SPECIFICATIONS

SPECIFICATIONS

Minimalist aluminium patio with rainproof fabric

Retractable fabric roof with ZIP screen technology

Some overhang (up to 1/3 projection, 1 m maximum)

Compact poles and side rails measuring 80 x 80 mm

Optional: motorised, solar and battery-powered 1m valance

Optional zipscreen and fixed side screen for more privacy

BENEFITS

Panoramic view thanks to minimalist design

The ZIP screen technology's balanced tension keeps the fabric smooth and flat in the side rails

Exhaustive choice of personalisation options



B128



OPTIONS

- Motorised solar-powered valance to 1 m long
- Adjustable pole height
- Customisable ZIP screens
- LED lighting in poles, side rails, and support beam
- Wall connection profile



OPERATION

- Somfy IO remote control

MAX. DIMENSIONS



6 x 5 m (without valance)



5 x 5 m (with valance)

Extendable in width



STANDARD COLOURS

RAL
7016 ST

RAL
9016 ST

HORIZONTAL

B128

HORIZONTAL SUN PROTECTION

Minimalism at its best and a horizontal fabric roof – that's what puts the B128 Pergola Horizontal Patio Cover a cut above. This pergola's sophisticated design also allows easy mounting for low-rise buildings, e.g. with low-pitch roofs or extensions. The shade cloth roof provides the perfect shade, allowing you to make the most of those sunny days outdoors.





BENEFITS & SPECIFICATIONS

SPECIFICATIONS

Minimalist aluminium patio cover offering sun protection only

Retractable fabric roof with ZIP screen technology

No minimum pitch requirement

Some overhang (up to 1/3 projection, 1 m maximum)

Compact poles and side rails measuring 80 x 80 mm

Optional: motorised, solar and battery-powered 1m valance

Optional zipscreen for more privacy

BENEFITS

Panoramic view thanks to minimalist design

The ZIP screen technology's balanced tension keeps the fabric smooth and flat in the side rails

Exhaustive choice of personalisation options



B128 P HORIZONTAL



OPTIONS

Motorised solar-powered valance to 1 m long

Customisable ZIP screen

LED lighting in poles, side rails, and support beam



OPERATION

Somfy IO remote control

MAX. DIMENSIONS



6 x 4 m (without valance)



5 x 4 m (with valance)

Extendable in width



STANDARD COLOURS

RAL
7016 ST

RAL
9016 ST





DELUXE PERGOLA.

The B128 XL is a lean-to awning and patio cover in one. ZIP screen technology allows the fabric roof to ascend or descend electrically. And the pergola's minimalist design guarantees a panoramic view when open. Add integrated screens to the sides to completely enclose your outdoor space and stay comfortably safe from sun, rain, and wind.



B128 XL

EXTENDABLE & MORE SPACIOUS THAN EVER.

The B128 XL is extendable in width, allowing you to make the most of your extended covered terrace. Ideal for hospitality businesses that want their customers to enjoy the terrace for longer. Thanks to built-in screens, atmospheric lighting and pleasant terrace heating, your terrace enjoys a lot of extra functionality and the experience becomes even cozier.





BLISS

BENEFITS & SPECIFICATIONS

SPECIFICATIONS

Smooth, water-resistant canopy

Integrated screens for full privacy

Hidden drainage

Sleek frame

Concealed mounting materials

Sturdy, concealed anchoring

BENEFITS

Multiple configuration options

The ZIP screen technology's balanced tension keeps the fabric smooth and flat in the side rails

Exhaustive choice of personalisation options

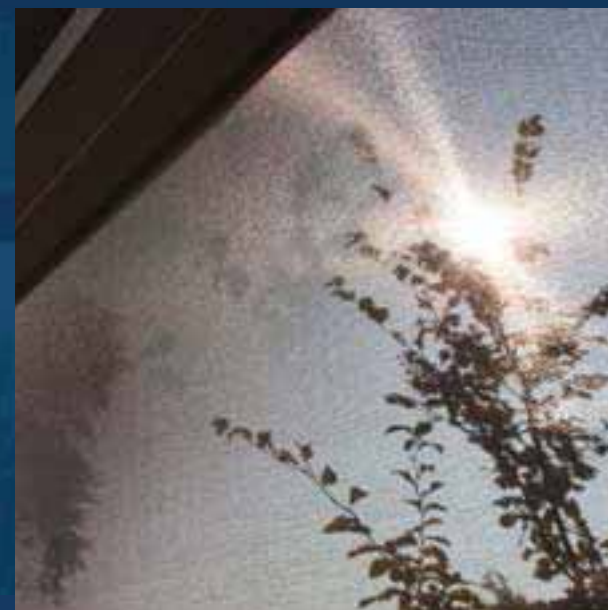

B128 XL



OPTIONS

- Integrated customisable ZIP screens
- Dimmable LED spots in frame
- LED lighting in poles, side rails and support beam
- Patio heating
- Door profile



OPERATION

- Somfy IO remote control



MAX. DIMENSIONS

- 6 x 5 m
- 5 x 6 m
- Extendable in width



STANDARD COLOURS



B300

ALWAYS THE RIGHT VIBE.

Resistant to all the elements and dirt – the Brustor B300's durable fabric roof provides perfect protection. The horizontal layout and concealed mounting fixtures result in a sleek design. Without a screw in sight, the frame's hidden drainage system invisibly drains water away. User-friendly remote control or smartphone control.

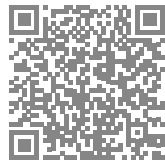



BENEFITS & SPECIFICATIONS

SPECIFICATIONS

Modern retractable roof with waterproof fabric

Integrated screens for full privacy

Concealed mounting materials

Comes standard with IO operation, remote control included

Hidden drainage

Stand alone or wall-attached

BENEFITS

Waterproof retractable roof that can be adjusted to any position

Maximise light by opening the roof all the way

Light and shade that's just right



B3000



OPTIONS

Integrated customisable ZIP screens

Dimmable LED spots in frame

Indirect LED lighting along gutters (UP/DOWN)

Patio heating

Electrical socket in pole

Bluetooth speakers

Door profile



OPERATION

Somfy IO remote control

MAX. DIMENSIONS



7 x 4 m (single roof)



7 x 7 m (double roof with two additional door profiles)



Extendable along the width



STANDARD COLOURS











RAL
7016 ST

RAL
9016 ST

TYPES

CONFIGURATION OPTIONS

Several configuration options are available depending on the type of patio cover. For example, some can be configured with a door profile, wall-attached, L-configuration or star configuration.

	B160 XL	B200 (XL)	B250 XL	B600 S	B700	B720	B800	B128	B128 XL	B300
 Frame only	✓	✓	✓	✓	✓	✓				✓
 Stand-alone	✓	✓	✓	✓			✓			✓
 Stand-alone with overhang		✓	✓							✓
 Coupled roof		✓	✓		✓	✓				✓
 Coupled roof with door profile		✓	✓		✓	✓				✓
 Coupled in length or width	✓	✓	✓		✓			✓	✓	✓
 L-configuration		✓	✓							
 Star configuration		✓	✓							
 Wall-attached version	✓	✓	✓	✓	✓	✓	✓	✓	✓	✓
 Wall-attached version with door profile		✓	✓	✓	✓	✓	✓	✓	✓	✓
 Wall-attached version with overhang		✓	✓		✓	✓				

OPTIONS AND TECHNICAL INFORMATION

BASIS	B160 XL	B200	B200 XL	B250 XL	B600 S	B700	B720	B800	B128 P	B128 XL	B300
Louvers	21 cm	16 cm	21 cm	21 cm	21 cm		21 cm				
Canopy									☑	☑	☑
Retractable					☑				☑	☑	☑
Channels	4	4	4	4	4	4	4	4	in lead rail	in lead rail	4
built-in roof	☑	☑	☑	☑	☑	☑	☑				☑
Lean-to / 2 poles	☑	☑	☑	☑	☑	☑	☑		☑	☑	☑
Stand-alone / 4 poles	☑	☑	☑	☑	☑			☑			☑
Coupling along the length	☑	☑	☑	☑		☑					
Coupling along the width		☑	☑	☑		☑			☑		☑
Max. dimensions / 1 roof element	L 6m x B 4,5m	L 7m x B 3,5m	L 7m x B 4m L 6m x B 4,5m	L 6,06m x B 4m	L 6,09m x B 4m	L 6m x B 2,5m		L 7m x B 4m	U 5m x B 6m	L 5,92m x B 6m	L 7m x B 4m B 4m x L 7m
Max. dimensions / 2 roof elements (on 4 poles)		L 6m x B 6m	L 6m x B 6m	L 6m x B 6m		L 6m x B 4m L 5m x B 5m	L 6m x B 7m				L 6m x B 6m
White colour RAL 9016 textured	☑	☑	☑	☑	☑	☑	☑	☑	☑	☑	☑
Anthracite grey RAL 7016 textured	☑	☑	☑	☑	☑	☑	☑	☑	☑	☑	☑
Quartz grey RAL 7039 textured as standard		Frame only	☑								
Jet black RAL 9005 textured 		Frame only	☑								
Brustor Connect App					option						
OPTIONS	B160 XL	B200	B200 XL	B250 XL	B600 S	B700	B720	B800	B128 P	B128 XL	B300
RAL colour of your choice	☑	☑	☑	☑	☑	☑	☑	☑	☑	☑	☑
Built in screens		☑	☑	☑	☑	☑	☑	☑		☑	☑
Surface-mounted screens	☑								☑		
Sliding panels	☑	☑	☑	☑	☑	☑	☑	☑		☑	☑
Woodlook louvers	☑		☑				☑				
Dimmable white LED strip/louvers	☑	☑	☑	☑	☑		☑				
Dimmable RGB LED strip/louvers	☑		☑	☑							
Dimmable white LED strip/structure									Pole / rail & support beam	Pole / rail & support beam	
Dimmable RGB LED strip/structure									Support beam & rail	Support beam & rail	
Indirect LED lighting on gutters UP/DOWN	☑	☑	☑		☑			☑		☑	☑
Direct LED lighting on gutters DOWN											
Indirect LED lighting in structure											
Spots in structure		☑	☑	☑	☑	☑	☑	☑		☑	☑
Rain and/or snow sensor	☑	☑	☑	☑	☑		☑		wind sensor	wind sensor	
Bluetooth speakers		☑	☑	☑	☑	☑	☑	☑			
Electrical socket in pole	☑	☑	☑	☑	☑	☑	☑	☑			☑
Patio heaters	☑	☑	☑	☑	☑	☑	☑	☑	☑	☑	☑
Ground anchor	☑	☑	☑	☑	☑	☑	☑	☑		☑	☑
Floor plate / Corner floor plate	☑	☑	☑	☑	☑	☑	☑	☑	☑	☑	☑
Door profile		☑	☑	☑	☑	☑	☑	☑		☑	☑

OPTIONS

PERSONALISE
YOUR PATIO COVER

Go for untold comfort by personalising your patio cover down to the last detail. Brustor makes it happen with a wide range of options. Set the mood with LED lighting, or keep yourself and your guests warm and toasty on those chilly nights with patio heating. Screens in your favourite colour, built-in speakers, and sockets: just imagine and make it happen.



PATIO HEATING

Designer patio heating for those chilly evenings. Select one or more. User-friendly remote operation. Available in a black, white, or anodised finish.



BLUETOOTH SPEAKERS

Splash-proof IP65 Bluetooth speakers in black or white



BUILT-IN ELECTRICAL SOCKET

Splash-proof IP54 electrical socket on the inside of the poles



LEDSTRIPS IN LOUVERS

Dimmable ledstrips in louvers.



LED SPOTS

Dimmable ledspots in frame or support beams.



LED LIGHTING ALONG GUTTERS

Dimmable ledlighting along gutters, UP/DOWN.





INTEGRATED SCREENS

OPTIMALLY PROTECTED

Choose integrated ZIP screens to screen yourself and your loved ones from the wind, sun, or rain and to keep insects at bay. Brustor ensures that the ZIP screens are integrated in the frame of the pergola to keep the design as elegant as possible





EXTRA ATMOSPHERE & COSINESS

SLIDING PANELS

Bring character and personality to your outdoor space with our versatile sliding doors. Whether you have a soft spot for the timeless allure of wood, lean toward the sleek and contemporary appearance of aluminum, or aim for the perfect blend of wood's warmth and aluminum's resilience, we give you the freedom to customize your outdoor setting to your preferences. It's your outdoor space, after all – your unique choice.

You can choose from three types of filling

- Wood louvers - thermal poplar
- Aluminium louvers - RAL colour of your choice
- Aluminium louvers - wood look



WOODLOOK LOUVERS

Brustor wood-look louvers were carefully designed to mimic the natural beauty of natural oak. What makes these louvers unique is that they are made of high-quality, powder-coated aluminium. As a result, they retain not only the warm look of wood, but also the durability and ease of maintenance of aluminium.

TECHNOLOGICAL BENEFITS

Contemporary design with concealed screws



Patented LED strips in louvers



Patented corner reinforcement in the poles for rock-solid stability



Concealed, easy adjuster to compensate for uneven surfaces and provide solid support. Patented



HIDDEN DRAINAGE

Three drainage systems are available based on the environment. The default is water that drains from the support profile's base. However, your sun protection system can also be configured to drain directly into the sewage system through the base anchor or drain through an output in the profile's side.

- 1 Standard drainage at profile base
- 2 Drainage through anchor
- 3 Optional drainage through side output

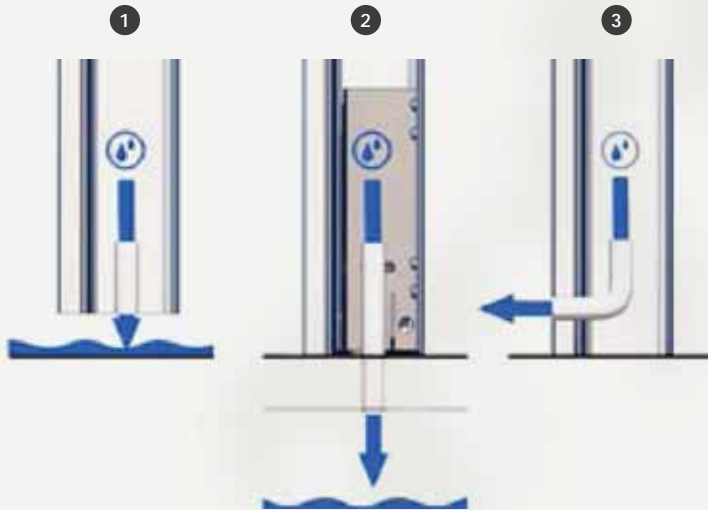

ANCHORING

Various anchor types are available depending on the type of pergola, location, foundation and weather conditions. And sturdy, streamlined design ensures that your patio cover can weather it all.

- A Standard pole support
- B Reinforced base
- C Floor plate 20 x 20 cm
- D Corner floor plate 20 x 20 cm
- E Ground anchor

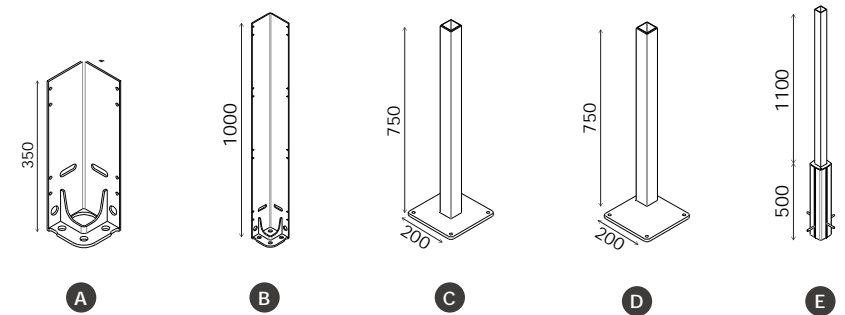

QUALITY & WARRANTY

BRUSTOR GUARANTEES A HIGH-QUALITY FINISH

COATING

Brustor patio covers are available standard in select classic colours. However, you can have any Brustor pergola powder coated in the colour of your choice. Qualicoat-certified, this powder coating meets the highest standards. Moreover, you can significantly extend your powder-coated patio cover's life with the Brustor Cleaning Kit.



FABRICS

Our screens and fibreglass fabrics are available in a wide range of colours and patterns. Ask your dealer to show you the full collection. All our fabrics have an M2 fire rating.



10 YEAR BRUSTOR WARRANTY

“Outdoor Living’ sun protection solutions feature high-quality, aluminium motorised patio covers with precision engineering. The Outdoor Living system is especially water resistant but not guaranteed 100% waterproof.

Get the most out of your BRUSTOR solution and enjoy years of sun protection with your warranty booklet, full of tips and key specifications. For individual products, please enquire about our special warranty conditions.

Exceptions: 2-year warranty on LED lighting and patio heating.
5 year warranty on fabric, motor and electronics.

These warranty conditions are not conclusive. For our comprehensive terms and conditions see www.brustor.com



CE CERTIFICAAT

All Brustor sun protection solutions comply with European safety standards.





PATIO COVERS FOR THE HOSPITALITY INDUSTRY

Brustor patio covers are a fantastic solution for the hospitality sector's needs. The B200 (XL) and B250 XL can easily be set up for a range of configurations, from stand-alone, lean-to, flush-mount and coupled to a star- or an L-shaped layout.

A generous selection of add-on features helps boost customer comfort, including windproof screens, dimmable LED lighting, patio heating, and more. Brustor helps craft a stylish outdoor space with the perfect ambience. Cosy and protected in any weather, your business is bound to benefit.



BRUSTOR®

OUTDOOR SUN SYSTEMS

Muizelstraat 20 | 8560 Gullegem | Belgium

T +32 (0)56 53 18 53 | info@brustor.com

www.brustor.com



Outdoor Living



Awnings



Conservatory Aw-
ning



Screens